

# Quick Start Guide

Dual-Band Wi-Fi 6 Indoor Access Point  
EAP102

## Package Contents

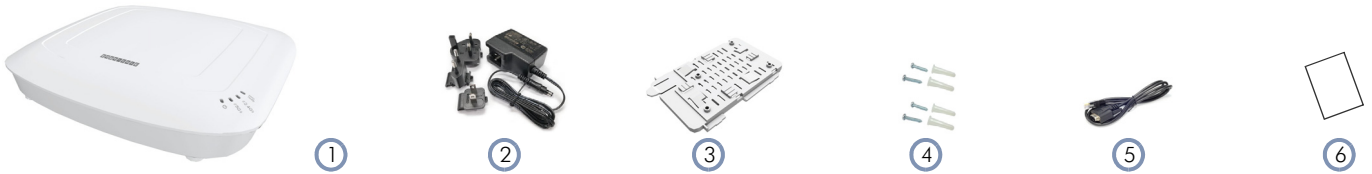

1. EAP102 access point
2. AC power adapter with international socket converters
3. Mounting bracket accessory
4. Screw kit—4 screws and 4 plugs
5. Console cable—RJ-45 to DB-9 (TIP SKU only)
6. QR code card

## Overview



1. 12 VDC power input
2. Uplink(PoE) Port: 2.5Gbps connection to 802.3at PoE LAN device.
3. LAN Port: 2.5Gbps connection to LAN devices.
4. Console port (reserved for future use)
5. USB 2.0 port (reserved for future use)
6. Restart/Reset button:
  - A quick press restarts the system.
  - A 5 second press resets to factory defaults.
7. System LED Indicators:
  - Uplink(PoE): On (link), Blinking (traffic)
  - 2.4G: On (radio on), Blinking (traffic)
  - 5G: On (radio on), Blinking (traffic)
  - Status: On (power OK), Blinking (boot up)

## Installation



**Warning:** For indoor use only. The access point, AC power adapter, and all connected cables are not for outdoor use.

### 1 Mount the AP

#### a. Mounting on a Wall

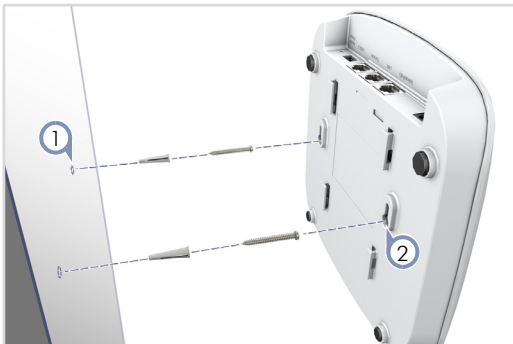

1. At the installation location on the wall, set two screws in the wall 128 mm (5.0 in.) apart. Use the wall plugs and screws included in the screw kit.



**Note:** Drill 2.5 mm ( $\pm 0.2$  mm) holes for M3 self-tapping screws, or 4.5 mm ( $\pm 0.2$  mm) holes for nylon wall plugs.

2. Slide the AP's wall mounting slots down onto the screws so that the unit is secure.

#### b. Mounting on a Suspended Ceiling T-Bar



1. Slide the bracket accessory onto the base of the AP until it clicks into its locked position.
2. Position the ceiling-mount clip holders on either side of the T-bar, and then turn the AP until the two clips lock it to the T-bar.



**Note:** The AP mounting supports two different sizes of suspended ceiling T-bars. The position illustrated above is for 24.5 mm bars. Use the position at a 90 degrees angle for 15 mm bars.

### c. Mounting on a Ceiling Without T-Bars

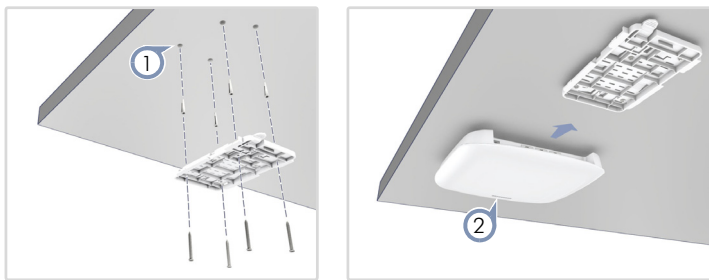

1. At the installation location on the ceiling, use the mounting bracket to mark four holes for the plugs and screws (included in the screw kit). Drill four holes for the plugs, and then insert the plugs and tap them flush with the ceiling surface. Use the four screws to secure the bracket to the ceiling (screw torque must be less than 6 kgf.cm).
2. Slide the AP onto the bracket until it snaps into its secured position.

## 2 Connect Cables

### a. Connect LAN Cables

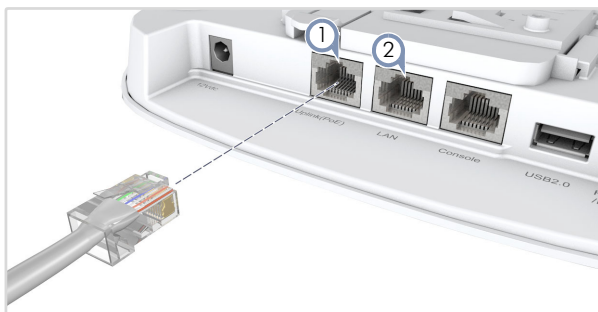

1. Connect Category 5e or better cable to the Uplink(PoE) 2.5GBASE-T RJ-45 port. When connected to a PoE source, the Uplink(PoE) port connection provides power to the unit.
2. (Optional) Connect a local LAN switch or computer to the LAN 2.5GBASE-T RJ-45 port.

### b. (Optional) Connect AC Power Adapter

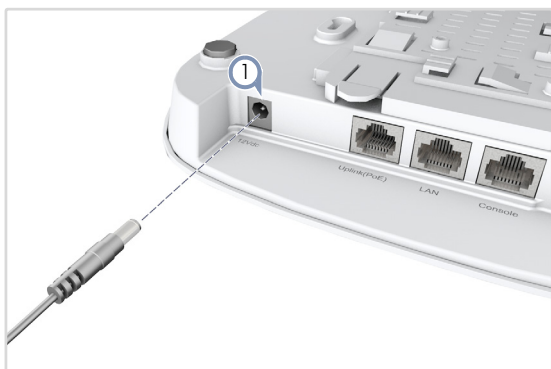

1. Connect the AC power adapter to the DC power jack on the AP and then plug the adapter into a nearby AC power source.

## 3 Check AP LEDs



1. Uplink(PoE) LED — on green for a valid link.
2. 2.4G and 5G LEDs — on green for radio enabled.
3. Power/Status LED — on green for normal operation.

## 4 Connect to the Web User Interface

1. Connect a PC directly to the AP's LAN port.
2. Set the PC IP address to be on the same subnet as the AP LAN port default IP address. (The PC address must start 192.168.2.x with subnet mask 255.255.255.0.)
3. Enter the AP's default IP address of 192.168.2.1 into the web browser address bar.

**Note:** To connect to the web interface using the Uplink(PoE) port, the IP address is automatically assigned through DHCP by default. If a DHCP server is unreachable, the Uplink(PoE) port reverts to a fallback IP address of 192.168.1.10.

4. On first-time log in to the web interface, the Setup Wizard starts and you must select how the AP will be managed, either using the ecCLOUD controller, an EWS-Series controller, or in stand-alone mode.

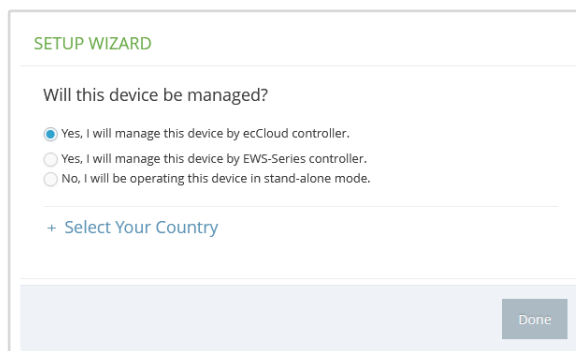

5. Continue with the Setup Wizard to make other settings:
  - **Cloud-Managed Mode:** Select the country of operation.
  - **EWS-Series Controller Mode:** Complete the CAPWAP setup, use the default wireless network setting or customize the network name, then set a password (the default user name is "admin" with password "admin"), and select the country of operation.
  - **Stand-Alone Mode:** Use the default wireless network setting or customize the network name, then set a password (the default user name is "admin" with password "admin"), and select the country of operation.
6. Click "Done" to finish the setup wizard.

**Note:** For more information on the Setup Wizard and AP configuration, refer to the *User Manual*.

## 5 (Optional) QR Code Onboarding

For quick set up and registration of your AP with the ecCLOUD controller, you can scan the QR code on the AP using a phone.

Follow these steps:

1. Make sure the AP is powered on and connected to the Internet.
2. Use the camera (iPhone) or a barcode app (Android) on your phone to scan the AP's QR code. The QR code is printed on a label on the base of the AP.



3. When a message pops up, tap "yes" to join the Wi-Fi network (iPhone requires you to go to Settings > Wi-Fi or open the browser for the message to pop up).

The web browser should open and redirect to the Setup Wizard page.

**Note:** If the phone cannot connect to the Wi-Fi network, type the SSID (network name) and password manually. The SSID name is the AP serial number (for example, EC0123456789), and the password is the AP MAC address (for example, 903CB3BC1234).

4. After setting a new password and the regulatory country, select to manage the AP using the ecCLOUD controller, an EWS-Series controller, or to manage the AP in stand-alone mode.

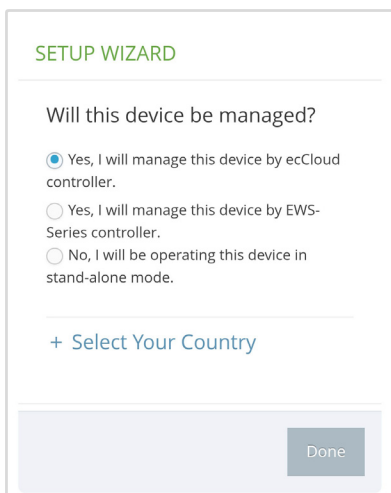

- a. **Stand-Alone Mode:** Use the default wireless network setting or customize the network name and password. Tap "Done" to finish the Setup Wizard.

Wait about two minutes for the AP configuration to update, and then connect to the wireless network name configured in the setup wizard. The browser is then redirected to the login page of the AP.

- b. **EWS-Series Controller Mode:** Complete the CAPWAP setup, then set a password and select the country of operation. Tap "Done" to finish the setup wizard.

- c. **Cloud-Managed Mode:** Tap "Done" to finish the setup wizard and the browser is redirected to the ecCLOUD login page.

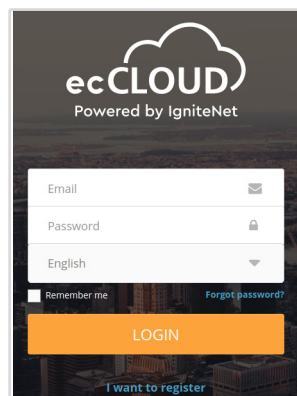

If you already have an ecCLOUD account, log in and select a site for the AP. The AP is automatically registered for cloud management. After you tap "Save," wait about two minutes for the cloud controller to configure the AP.

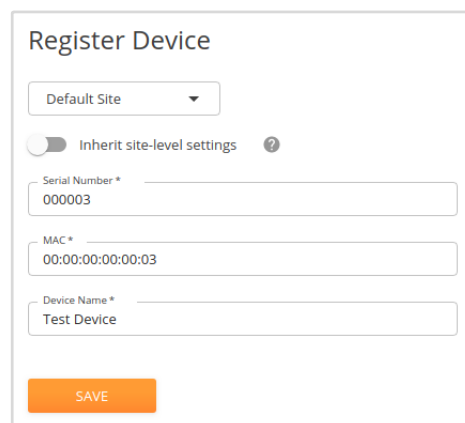

If you do not have an ecCLOUD account, tap "I want to register" and first set up an account. Create a cloud and site before confirming the regulatory country. After tapping "Next," the AP is then automatically registered for cloud management. After you tap "Save," wait about two minutes for the cloud controller to configure the AP.

**Note:** Refer to the *Edgecore ecCLOUD Controller User Manual* for more information on setting up and configuring APs through ecCLOUD.

## Safety and Regulatory Information

### FCC Class B

This equipment has been tested and found to comply with the limits for a Class B digital device, pursuant to Part 15 of the FCC Rules. These limits are designed to provide reasonable protection against harmful interference in a residential installation. This equipment generates, uses and can radiate radio frequency energy and, if not installed and used in accordance with the instructions, may cause harmful interference to radio communications. However, there is no guarantee that interference will not occur in a particular installation. If this equipment does cause harmful interference to radio or television reception, which can be determined by turning the equipment off and on, the user is encouraged to try to correct the interference by one of the following measures:

- Reorient or relocate the receiving antenna
- Increase the separation between the equipment and receiver
- Connect the equipment into an outlet on a circuit different from that to which the receiver is connected
- Consult the dealer or an experienced radio/TV technician for help

**FCC Caution:** Any changes or modifications not expressly approved by the party responsible for compliance could void the user's authority to operate this equipment.

This device complies with Part 15 of the FCC Rules. Operation is subject to the following two conditions: (1) This device may not cause harmful interference, and (2) this device must accept any interference received, including interference that may cause undesired operation.

For product available in the USA/Canada market, only channel 1~11 can be operated. Selection of other channels is not possible.

### IMPORTANT NOTE: FCC Radiation Exposure Statement:

This equipment complies with FCC radiation exposure limits set forth for an uncontrolled environment. This equipment should be installed and operated with minimum distance 24 cm between the radiator and your body.

### Industry Canada

This device contains licence-exempt transmitter(s)/receiver(s) that comply with Innovation, Science and Economic Development Canada's licence-exempt RSS(s). Operation is subject to the following two conditions:

- (1) This device may not cause interference.
- (2) This device must accept any interference, including interference that may cause undesired operation of the device.

*Cet appareil contient des émetteurs / récepteurs exempts de licence qui sont conformes au (x) RSS (s) exemptés de licence d'Innovation, Sciences et Développement économique Canada. L'opération est soumise aux deux conditions suivantes:*

- (1) Cet appareil ne doit pas provoquer d'interférences.*
- (2) Cet appareil doit accepter toute interférence, y compris les interférences susceptibles de provoquer un fonctionnement indésirable de l'appareil.*

The device for operation in the band 5150–5250 MHz is only for indoor use to reduce the potential for harmful interference to co-channel mobile satellite systems.

*Les dispositifs fonctionnant dans la bande 5150-5250 MHz sont réservés uniquement pour une utilisation à l'intérieur afin de réduire les risques de brouillage préjudiciable aux systèmes de satellites mobiles utilisant les mêmes canaux.*

### IMPORTANT NOTE: IC Radiation Exposure Statement:

This equipment complies with IC RSS-102 radiation exposure limits set forth for an uncontrolled environment. This equipment should be installed and operated with minimum distance 28 cm between the radiator and your body.

*Cet équipement est conforme aux limites d'exposition aux rayonnements IC établies pour un environnement non contrôlé. Cet équipement doit être installé et utilisé avec un minimum de 28 cm de distance entre la source de rayonnement et votre corps.*

### CE Statement

This equipment complies with EU radiation exposure limits set forth for an uncontrolled environment. This equipment should be installed and operated with minimum distance 20 cm between the radiator and your body.

The device is restricted to indoor use only when operating in the 5150 to 5350 MHz frequency range.

All operational modes:

2.4 GHz: 802.11b, 802.11g, 802.11n (HT20), 802.11n (HT40), 802.11ac (VHT20), 802.11ac (VHT40), 802.11ax (HE20), 802.11ax (HE40)

5 GHz: 802.11a, 802.11n (HT20), 802.11n (HT40), 802.11ac (VHT20), 802.11ac (VHT40), 802.11ac (VHT80), 802.11ax (HE20), 802.11ax (HE40), 802.11ax (HE80)

The frequency and maximum transmitted power limit in EU are listed as below:

2412-2472 MHz: 20 dBm  
5150-5350 MHz: 23 dBm  
5500-5700 MHz: 30 dBm



AT	BE	BG	CH	CY	CZ
DE	DK	EE	EL	ES	FI
FR	HR	HU	IE	IS	IT
LI	LT	LU	LV	MT	NL
NO	PL	PT	RO	SE	SI
SK	TR	UK			

The abbreviations of the countries, as prescribed in above table, where any restrictions on putting into service or any requirements for authorization of use exist.



CE Mark Declaration of Conformance for EMI and Safety (EEC)

This information technology equipment is in compliance with the Directive 2014/53/EU and Directive 2014/35/EU.

The Declaration of Conformity (DoC) can be obtained from [www.edge-core.com](http://www.edge-core.com) -> support -> download.

### Japan VCCI Statement

この装置は、クラスB機器です。この装置は、住宅環境で使用することを目的としていますが、この装置がラジオやテレビジョン受信機に近接して使用されると、受信障害を引き起こすことがあります。

取扱説明書に従って正しい取り扱いをして下さい。

VCCI — B

5 GHz band (W52, W53): Indoor use only (except communicate to high power radio)



## NCC Statement (Taiwan)

### NCC 警語

取得審驗證明之低功率射頻器材，非經核准，公司、商號或使用者均不得擅自變更頻率、加大功率或變更原設計之特性及功能。低功率射頻器材之使用不得影響飛航安全及干擾合法通信；經發現有干擾現象時，應立即停用，並改善至無干擾時方得繼續使用。前述合法通信，指依電信管理法規規定作業之無線電通信。低功率射頻器材須忍受合法通信或工業、科學及醫療用電波輻射性電機設備之干擾。

## NBTC (Thailand)

เครื่องโทรคมนาคมและอุปกรณ์นี้มีความสอดคล้องตามมาตรฐานหรือข้อกำหนดทางเทคนิคของ กสทช .

เครื่องวิทยุคมนาคมนี้มีระดับการแผ่คลื่นแม่เหล็กไฟฟ้าสอดคล้องตามมาตรฐานความปลอดภัยต่อสุขภาพของมนุษย์จากการใช้เครื่องวิทยุคมนาคมที่ คณะกรรมการกิจการโทรคมนาคมแห่งชาติ ประกาศกำหนด



เครื่องวิทยุคมนาคมนี้ ได้รับยกเว้น ไม่ต้องได้รับใบอนุญาตให้มี ใช้ซึ่งเครื่องวิทยุคมนาคมหรือตั้งสถานีวิทยุคมนาคมตามประกาศ กสทช. เรื่อง เครื่องวิทยุคมนาคม และสถานีวิทยุคมนาคมที่ได้รับยกเว้นไม่ต้องได้รับใบอนุญาตวิทยุคมนาคม ตามพระราชบัญญัติวิทยุคมนาคม พ.ศ. 2498



## NTC (Philippines)



## Warnings and Cautionary Messages



**Warning:** This product does not contain any serviceable user parts.

**Warning:** Installation and removal of the unit must be carried out by qualified personnel only.



**Caution:** Wear an anti-static wrist strap or take other suitable measures to prevent electrostatic discharge when handling this equipment.

**Caution:** Do not plug a phone jack connector in the RJ-45 port. This may damage this device.

**Caution:** Use only twisted-pair cables with RJ-45 connectors that conform to FCC standards.

限用物質含有情況標示聲明書						
Declaration of the Presence Condition of the Restricted Substances Marking						
設備名稱：無線接收器			型號 ( 型式 )：EAP102			
Equipment Name			Type Designation (Type)			
單元 Unit	限用物質及其化學符號 Restricted substances and its chemical symbols					
	鉛 (Pb)	汞 (Hg)	鎘 (Cd)	六價鉻 (Cr <sup>6+</sup> )	多溴聯苯 (PBB)	多溴二苯醚 (PBDE)
電路板組件 PCBA	—	○	○	○	○	○
機殼 Chassis	○	○	○	○	○	○
組合線 Cable ass'y	○	○	○	○	○	○
電源供應器 Power supply	—	○	○	○	○	○

備考 1. "超出0.1 wt %" 及 "超出0.01 wt %" 係指限用物質之百分比含量超出百分比含量基準值。  
 Note 1: "Exceeding 0.1 wt %" and "exceeding 0.01 wt %" indicate that the percentage content of the restricted substance exceeds the reference percentage value of presence condition.

備考 2. "○" 係指該項限用物質之百分比含量未超出百分比含量基準值。  
 Note 2: "○" indicates that the percentage content of the restricted substance does not exceed the percentage of reference value of presence.

備考 3. "—" 係指該項限用物質為排除項目。  
 Note 3: The "—" indicates that the restricted substance corresponds to the exemption.

## Hardware Specifications

### AP Chassis

Size (WxDxH)	201 x 195 x 39.8 mm (7.91 x 7.68 x 1.57 in.)
Weight	0.7 kg (1.54 lb)
Temperature	Operating: 0° C to 45° C (32° F to 113° F) Storage: -20° C to 60° C (-4° F to 140° F)
Humidity	Operating: 5% to 95% (non-condensing)

### Network Interfaces

Ports	Uplink(PoE) RJ-45 Port: 2.5GBASE-T, PoE PD LAN RJ-45 Port: 10/100/1000/2.5GBASE-T
2.4 GHz Radio	IEEE 802.11b/g/n/ac/ax
5 GHz Radio	IEEE 802.11a/n/ac/ax
Bluetooth Radio	IEEE 802.15.1
Radio Frequencies	2.4 – 2.4835 GHz (US, Canada, ETSI) 5.15 – 5.25 GHz (lower band) US/Canada, Europe 5.725 – 5.825 GHz (upper band) US/Canada

### Power Specifications

PoE Input Power	25 W max, 48 VDC–55 VDC; 802.3at-compliant
AC Power Adapter	AC Input: 100–240 VAC, 50-60 Hz DC Output: 12 VDC, 2 A

### Regulatory Compliances

Radio	EN300 328 V2.2.2 (2019-07) EN301 893 V2.1.1(2017-03) 47 CFR FCC Part 15.247 47 CFR FCC Part 15.407 NCC LP0002 MIC certification Rule, Article 2 Paragraph 1 Item 19 MIC certification Rule, Article 2 Paragraph 1 Item 19-3 and 19-3-2
Emissions	EN 301 489-1 V2.1.1 (2017-02) EN 301 489-17 V3.1.1 (2017-02) AS/NZS CISPR 32:2015, Class B 47 CFR FCC Rules and Regulations Part 15 Subpart B, Class B Digital Device CNS 13438 MIC certification Rule, Article 9 & Article 34
Safety	Low Voltage Directive (2014/35/EU, formerly 2006/95/EC, formerly 73/23/EEC) CNS 14336-1 IEC/EN 62368-1, IEC/EN 60950-1
Taiwan RoHS	CNS 15663